



1▪ Bubox Classic,
Brushed 316L stainless
steel, watertight floorbox
with secure opening

BUBOX

by MODELEC

Inspiration sourcebook	20
Our finishes	22
BUBOX CLASSIC	26
BUBOX LINE	30
Kit and accessories	32
Installation solutions	33

INSPIRATION SOURCEBOOK



1 & 2 • Bubox Classic,
Brushed 316L stainless
steel, watertight floorbox
with standard opening



OUR FINISHES

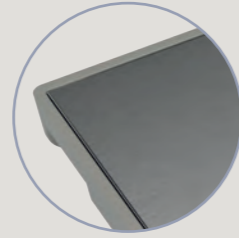

BUBOX CLASSIC

BUBOX CLASSIC

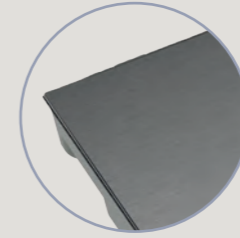

BUBOX LINE

BRUSHED 316L STAINLESS STEEL LID - /2



SCHUKO SOCKET - BFC101/2

BRUSHED 316L STAINLESS STEEL LID - /2

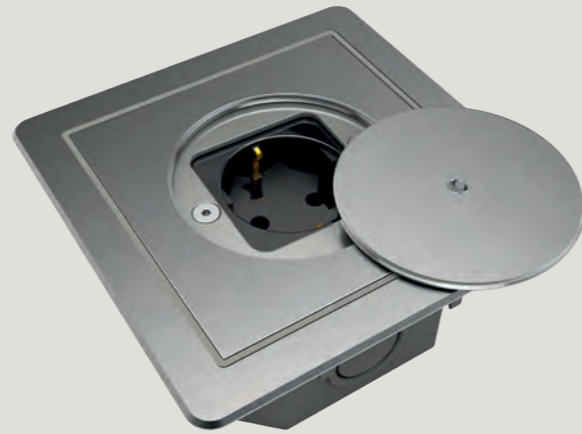

TERRACE KIT - BFC108/2
SCHUKO SOCKET - BFC111/2

BRUSHED 316L STAINLESS STEEL LID - /2

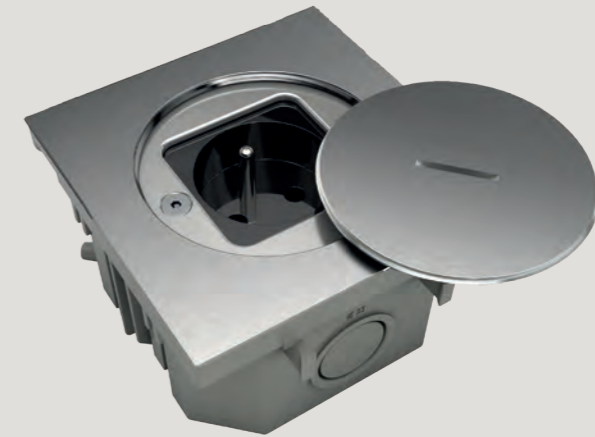

2P+T FRANCO-BELGIAN SOCKET - BFL102/2

BUBOX CLASSIC

BUBOX CLASSIC

BUBOX LINE

BRUSHED RAW BRASS LID - /1

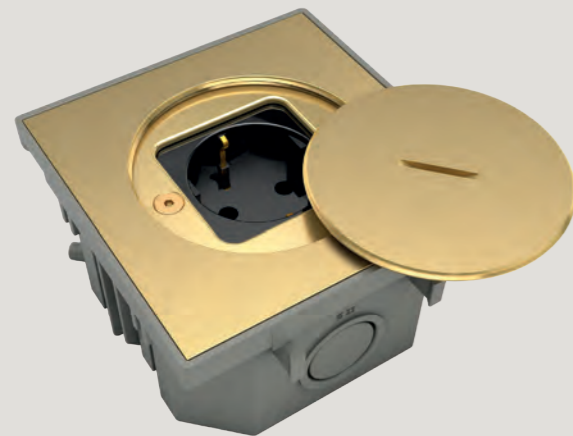

SCHUKO SOCKET - BFC101/1

BRUSHED RAW BRASS LID - /1

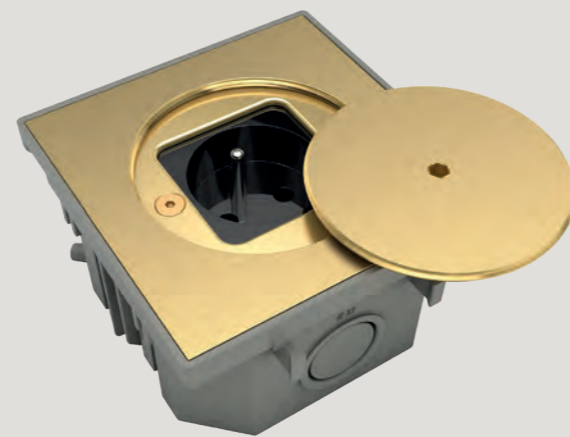

2P+T FRANCO-BELGIAN SOCKET - BFC112/1

BRUSHED RAW BRASS LID - /1

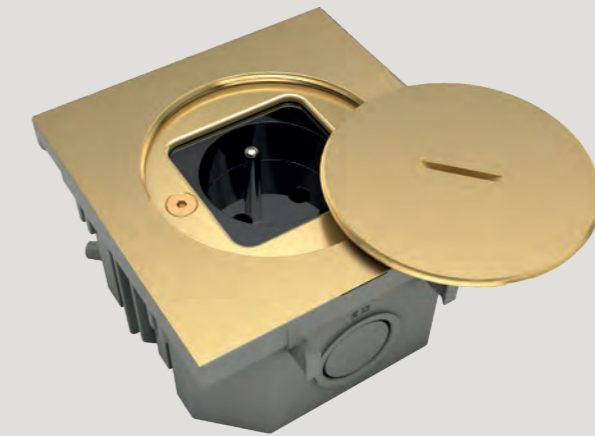

2P+T FRANCO-BELGIAN SOCKET - BFL102/1

BUBOX BY MODELEC

Discover our IP67 watertight floorbox, combining modern design and cutting-edge technology to meet all your electrical needs, whether indoors or outdoors.

Designed to guarantee optimum protection against dust and water splashes, our floor sockets are ideal for demanding environments.

PROTECTION RATING

IP67 Closed socket

IP20 Opened socket

IK10 Shock resistance

2000 kg Crush resistance

INOX 316L Marine use, corrosion resistance

+120°C Maximum temperature

✓ TIMELESS DESIGN

A sleek, attractive cover with no visible screws, made from raw brushed brass or brushed 316L stainless steel, ideal for aggressive environments. Often used for marine applications, 316L stainless steel is highly resistant to corrosion (seaside, swimming pool...) A discreet, elegant design that blends harmoniously into both classic and contemporary interiors.

✓ INSTALLATION ON ANY TYPE OF FLOOR

For smoothed or waxed concrete, tiles, parquet, joists, hollow floors, wooden or stone terraces, etc.

✓ SAFETY

Automatic earthing, factory-fitted seals, anti-condensation drain included. A ready-to-install product, supplied with all installation accessories.

✓ ROBUSTNESS AND HIGH PROTECTION RATINGS

Our range of watertight floorbox has the highest protection ratings on the market, with high impact resistance (IK10) and crush resistance (2 tonnes). This protection is further enhanced by solid covers 5mm thick for **BUBOX CLASSIC** and 6mm thick for **BUBOX LINE**.

1 • Bubox Classic, watertight floorbox and Aquastop, Brushed 316L stainless steel



BUBOX BY MODELEC

The BUBOX quality with every detail

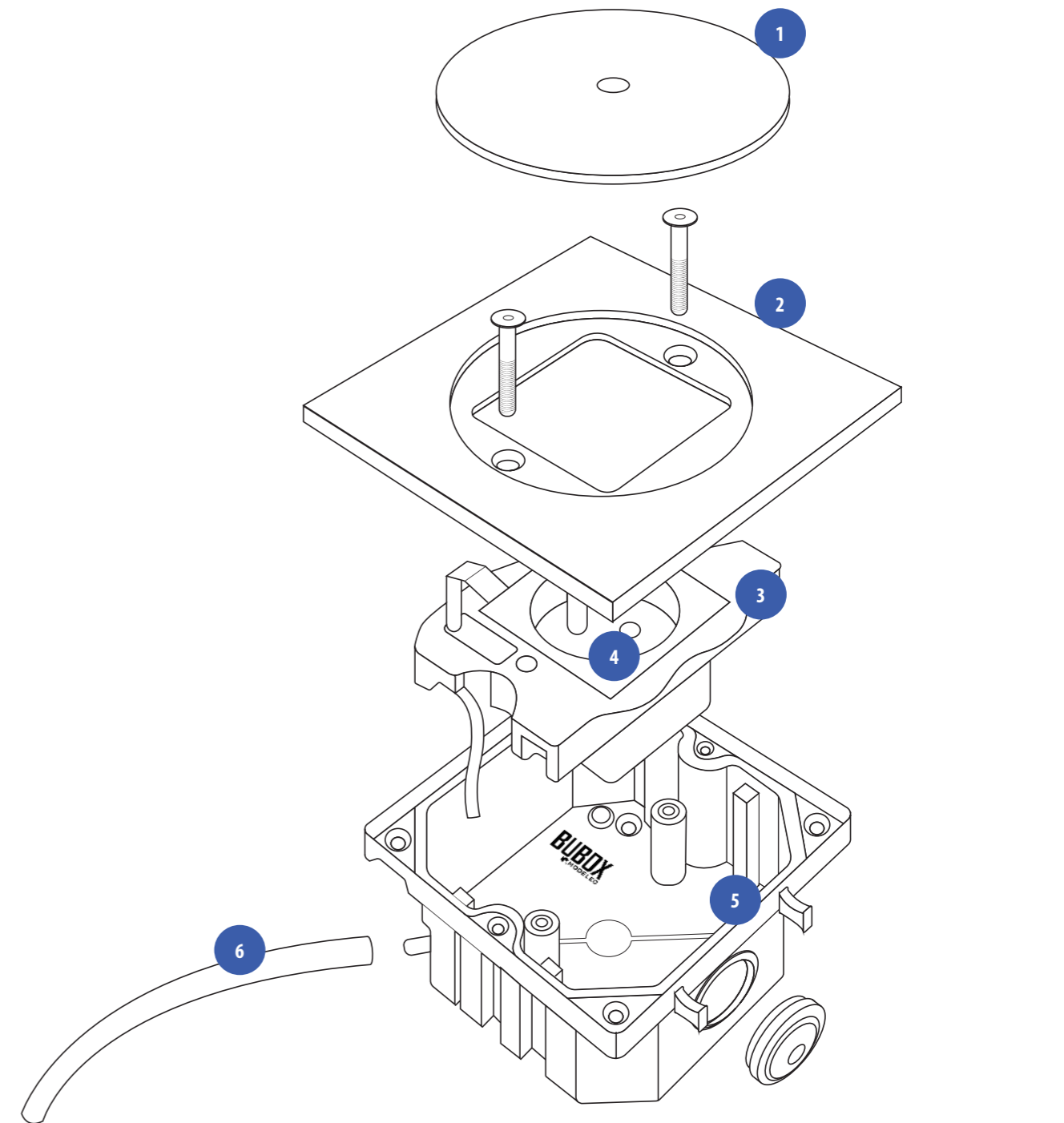

- 1 Screw-on lid
With 2 opening options
- 2 Cover
Integrated seal
- 3 Mechanism support
Automatic grounding
- 4 Mechanism
Mechanism dim : 45x45mm
- 5 Floor box
Flush-mounted box
- 6 Included anti-condensation drain
Enhanced safety and product longevity

BUBOX BY MODELEC

BUBOX CLASSIC

BUBOX CLASSIC watertight floorbox combine robustness, safety and stylish design to meet the needs of your projects, wherever they may be. They offer two options for opening their lid, including a secure opening.

Their flush-mounted boxes can be attached to each other to create multiple watertight floorbox. With the **terrace kit**, they can be installed in hollow ground, while with the **concrete kit**, they can be installed in concrete screed by reservation for a perfect flush installation.

The solution for all your outdoor projects.

EQUIPED WATERTIGHT FLOORBOX, STANDARD OPENING BUBOX CLASSIC

Our **BUBOX CLASSIC** watertight floorbox are sold assembled with the mechanism and its support. Please refer to the diagram below.

Standard opening lid + mechanism + mechanism support

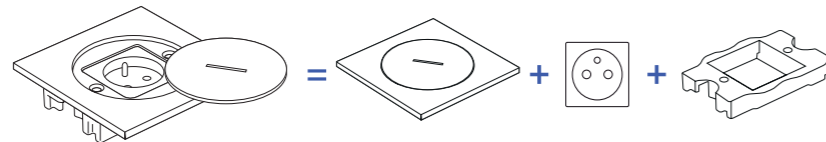

Watertight floorbox with standard opening BUBOX CLASSIC

Dimensions of the watertight floorbox (with its flush-mounted box): 100x100x59mm *

Brushed raw brass /1	Brushed 316L stainless steel /2
----------------------	---------------------------------

BFC101-		Standard opening lid + mechanism black schuko socket	BFC101/1	BFC101/2
BFC102-		Standard opening lid + mechanism black 2P+T franco-belgian socket	BFC102/1	BFC102/2
RETAIL PRICE EX TAX			121,10 €	109,20 €
BFC106-		Standard opening lid + mechanism black swiss socket	BFC106/1	BFC106/2
BFC107-		Standard opening lid + mechanism black italian bipasso socket	BFC107/1	BFC107/2
RETAIL PRICE EX TAX			131,40 €	119,40 €
BFC10411-		Standard opening lid + mechanism black screened RJ45 cat 6A	BFC10411/1	BFC10411/2
RETAIL PRICE EX TAX			131,40 €	119,40 €
BFC10421-		Standard opening lid + mechanism double black screened RJ45 cat 6A	BFC10421/1	BFC10421/2
RETAIL PRICE EX TAX			149,20 €	139,20 €

*The **BUBOX CLASSIC** watertight floorbox must be installed in the BUBOX flush-mounted box (ref: BFC160) to ensure overall waterproofing.

Don't forget to order the keys for standard and secure openings.

BUBOX BY MODELEC BUBOX CLASSIC

EQUIPED WATERTIGHT FLOORBOX, SECURED OPENING BUBOX CLASSIC

Secured opening lid + mechanism + mechanism support

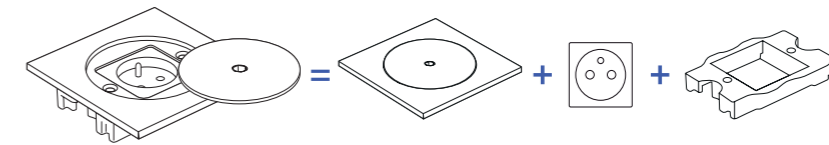

Watertight floorbox with secured opening BUBOX CLASSIC

Dimensions of the watertight floorbox (with its flush-mounted box): 100x100x59mm *

Brushed raw brass /1	Brushed 316L stainless steel /2
----------------------	---------------------------------

BFC111-		Secured opening lid + mechanism black schuko socket	BFC111/1	BFC111/2
BFC112-		Secured opening lid + mechanism black 2P+T franco-belgian socket	BFC112/1	BFC112/2
RETAIL PRICE EX TAX			121,10 €	109,20 €
BFC116-		Secured opening lid + mechanism black swiss socket	BFC116/1	BFC116/2
BFC117-		Secured opening lid + mechanism black italian bipasso socket	BFC117/1	BFC117/2
RETAIL PRICE EX TAX			131,40 €	119,40 €
BFC11411-		Secured opening lid + mechanism black screened RJ45 cat 6A	BFC11411/1	BFC11411/2
RETAIL PRICE EX TAX			131,40 €	119,40 €
BFC11421-		Secured opening lid + mechanism double black screened RJ45 cat 6A	BFC11421/1	BFC11421/2
RETAIL PRICE EX TAX			149,20 €	139,20 €



BRUSHED 316L STAINLESS STEEL /2 -
WATERTIGHT FLOORBOX WITH STANDARD OPENING

BRUSHED 316L STAINLESS STEEL /2 -
WATERTIGHT FLOORBOX WITH SECURED OPENING

BUBOX BY MODELEC



BUBOX CLASSIC

KIT AND ACCESSORIES FOR EQUIPED WATERTIGHT FLOORBOX BUBOX CLASSIC

⚠ The BUBOX flush-mounted box and the keys for opening the lids are essential accessories for the proper installation of your BUBOX watertight floorbox.

Flat-head and Allen key for watertight floorbox BUBOX CLASSIC

References

BFP001-	 flat-head key for standard opening watertight floorbox	BFP001
RETAIL PRICE EXT TAX		9,00 €
BFP002-	 Allen key for secured opening watertight floorbox	BFP002
RETAIL PRICE EXT TAX		2,90 €

Flush-mounted box for watertight floorbox BUBOX CLASSIC

Dimensions of the flush-mounted box: 100x100x59mm

Reference

BFC160-	 Flush-mounted box and its anti-condensation drain BUBOX CLASSIC	BFC160
RETAIL PRICE EXT TAX		29,75 €

⚠ The box must be installed with the **BUBOX CLASSIC** watertight floorbox.
(ref : BFC1XX/X)

Possibility to assemble multiple flush-mounted boxes using tenon-and-mortise joints.
Dimensions of a 4-box unit: 200 x 200 mm.

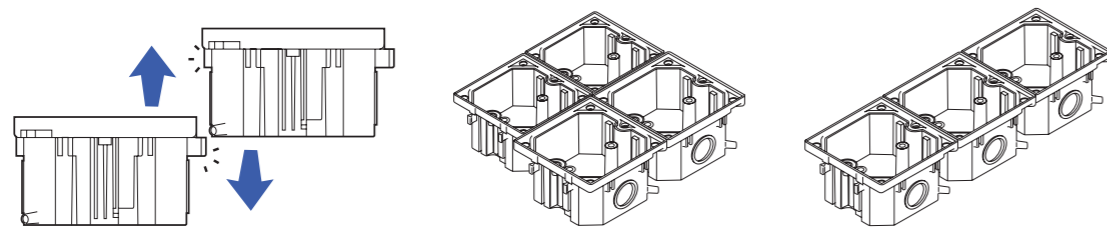

Terrace kit for watertight floorbox BUBOX CLASSIC

Exterior dimensions of the terrace kit: 125x125mm
Cut-out dimensions of the terrace kit: 108x108mm

Brushed raw brass /1
Brushed 316L stainless steel /2

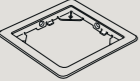
BFC108-	 Terrace kit for installation in technical flooring and/or raised floors (stainless steel screws) ⚠ Compatible with BUBOX CLASSIC only	BFC108/1	BFC108/2
RETAIL PRICE EXT TAX		139,00 €	119,00 €

BUBOX BY MODELEC

BUBOX CLASSIC

OPENING KEYS
BUBOX CLASSIC

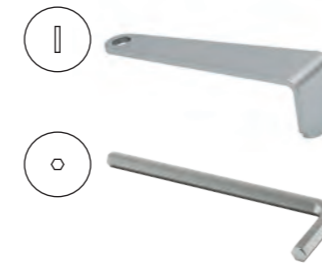

BRUSHED 316L STAINLESS STEEL TERRACE KIT
BUBOX CLASSIC



FLUSH-MOUNTED BOX
BUBOX CLASSIC

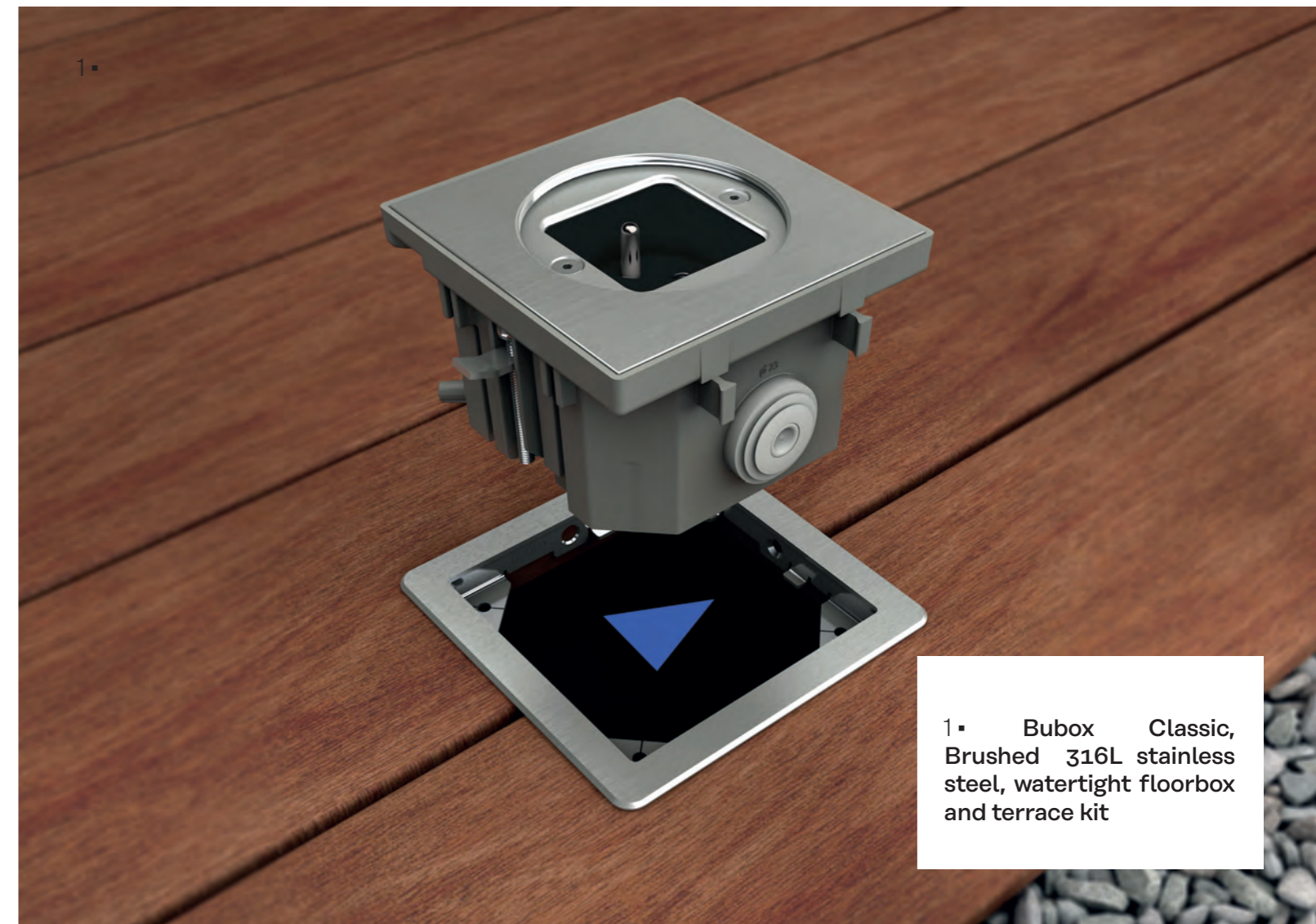

1▪ Bobox Classic, Brushed 316L stainless steel, watertight floorbox and terrace kit

BUBOX BY MODELEC

BUBOX LINE

Less is more.

While retaining the robustness and performance for which our watertight floorbox are renowned, and the technical advantages of BUBOX CLASSIC, **BUBOX LINE** is the perfect combination of top-of-the-range functionality and **refined design**. The lines of the flush-mount box disappear beneath the cover, giving way to an even more refined design. A meticulous finish for the most demanding projects, wherever they may be.

EQUIPED WATERTIGHT FLOORBOX, STANDARD OPENING BUBOX LINE

Our **BUBOX LINE** watertight floorbox are sold assembled with the mechanism and its support. Please refer to the diagram below.

Standard opening lid + mechanism + mechanism support

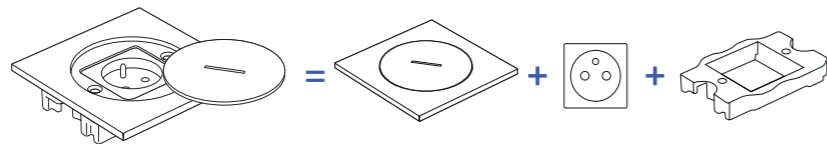

Watertight floorbox with standard opening BUBOX LINE

Dimensions of the watertight floorbox (with its flush-mounted box): 100x100x59mm *

Brushed raw brass /1	Brushed 316L stainless steel /2
----------------------	---------------------------------

BFL101-		Standard opening lid + mechanism black schuko socket	BFL101/1	BFL101/2
BFL102-		Standard opening lid + mechanism black 2P+T franco-belgian socket	BFL102/1	BFL102/2
RETAIL PRICE EX TAX			161,10 €	149,20 €
BFL106-		Standard opening lid + mechanism black swiss socket	BFL106/1	BFL106/2
BFL107-		Standard opening lid + mechanism black italian bipasso socket	BFL107/1	BFL107/2
RETAIL PRICE EX TAX			171,40 €	159,40 €
BFL10411-		Standard opening lid + mechanism black screened RJ45 cat 6A	BFL10411/1	BFL10411/2
RETAIL PRICE EX TAX			171,40 €	159,40 €
BFL10421-		Standard opening lid + mechanism double black screened RJ45 cat 6A	BFL10421/1	BFL10421/2
RETAIL PRICE EX TAX			189,20 €	179,20 €

*The **BUBOX LINE** watertight floorbox must be installed in the BUBOX flush-mounted box (ref: BFL160) to ensure overall waterproofing.

⚠ Don't forget to order the keys for standard openings.

BUBOX BY MODELEC

BUBOX LINE

KIT AND ACCESSORIES FOR EQUIPED WATERTIGHT FLOORBOX BUBOX LINE

⚠ The BUBOX flush-mounted box and the keys for opening the lids are **essential accessories** for the proper installation of your BUBOX watertight floorbox.

Flat-head key for watertight floorbox BUBOX LINE

References

BFP001-		flat-head key for standard opening watertight floorbox	BFP001
RETAIL PRICE EX TAX			9,00 €

Flush-mounted box for watertight floorbox BUBOX LINE

Dimensions of the flush-mounted box: 100x100x60mm

Reference

BFL160-		Flush-mounted box and its anti-condensation drain BUBOX LINE	BFL160
RETAIL PRICE EX TAX			39,00 €

⚠ The box must be installed with the **BUBOX LINE** watertight floorbox. (ref : BFL1XX/X)

Terrace kit for watertight floorbox BUBOX LINE

Exterior dimensions of the terrace kit: 125x125mm
Cut-out dimensions of the terrace kit: 108x108mm

Brushed raw brass /1	Brushed 316L stainless steel /22
----------------------	----------------------------------

BFL108-		Terrace kit for installation in technical flooring and/or raised floors (stainless steel screws) ⚠ Compatible with BUBOX LINE only	BFL108/1	BFL108/2
RETAIL PRICE EX TAX			169,00 €	149,00 €

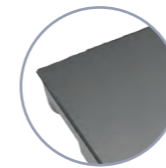

BUBOX LINE



BRUSHED 316L STAINLESS STEEL /2 -
WATERTIGHT FLOORBOX WITH STANDARD OPENING

BUBOX LINE

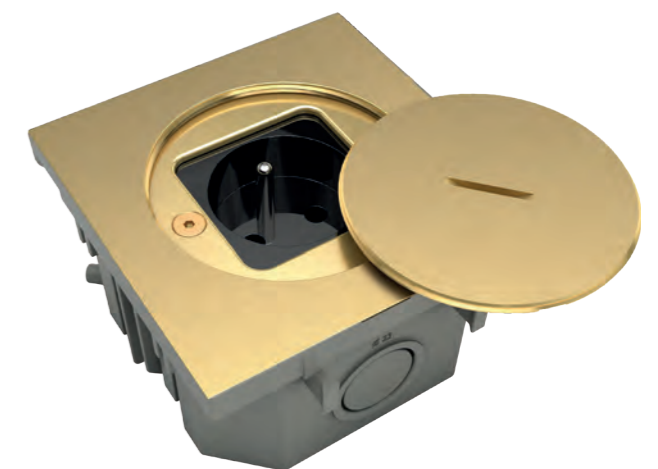

BRUSHED RAW BRASS /1 -
WATERTIGHT FLOORBOX WITH STANDARD OPENING

BUBOX BY MODELEC

Kit and accessories Bubox Classic and Bubox Line

KIT AND ACCESSORIES FOR EQUIPED WATERTIGHT FLOORBOX BUBOX CLASSIC ET BUBOX LINE

AQUASTOP BUBOX CLASSIC AND BUBOX LINE

Dimensions of the Aquastop: Ø84,5x63 mm

Aluminium natural anodized /90 Brushed 316L stainless steel /2

BFK107-		Aquastop Protects against splashes and dust even when the socket is connected.	BFK107/90	BFK107/2
RETAIL PRICE EX TAX			88,00 €	128,20 €

Leveling plate and concrete kit BUBOX CLASSIC AND BUBOX LINE

References

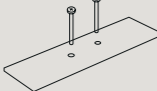
BFK119-		Leveling plate for all types of installations: joists, parquet, raised floors with cement screed, etc. <i>For a perfectly flush installation of your floor sockets</i>	BFK119
RETAIL PRICE EX TAX			9,00 €

BFK120-		Concrete kit for concrete block-out (Polystyrene block 180x180x100 mm + leveling plate)	BFK120
RETAIL PRICE EX TAX			28,00 €

BRUSHED 316L STAINLESS STEEL AQUASTOP BUBOX CLASSIC BUBOX LINE

IP20

IP67

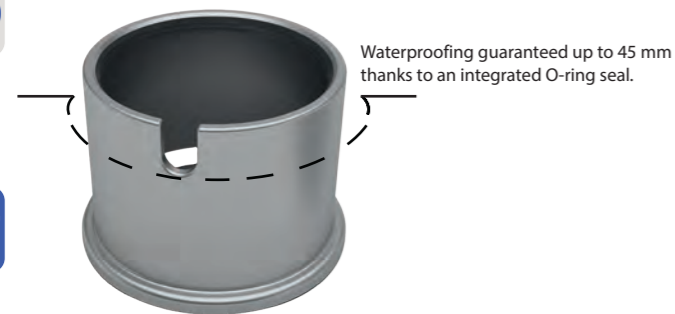

The Aquastop screws into place instead of the cap to protect connected sockets from splashes and high-pressure water washing.



CONCRETE KIT BUBOX CLASSIC BUBOX LINE



LEVELING PLATE BUBOX CLASSIC BUBOX LINE

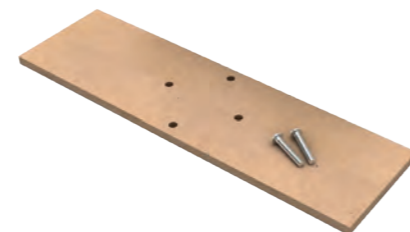

BUBOX BY MODELEC

Installation solutions

A solution for every project

BUBOX by MODELEC is designed to be installed in various types of flooring, suitable for both construction and renovation projects in the most demanding environments.

INSTALLATION IN CONCRETE SCREED BUBOX CLASSIC BUBOX LINE

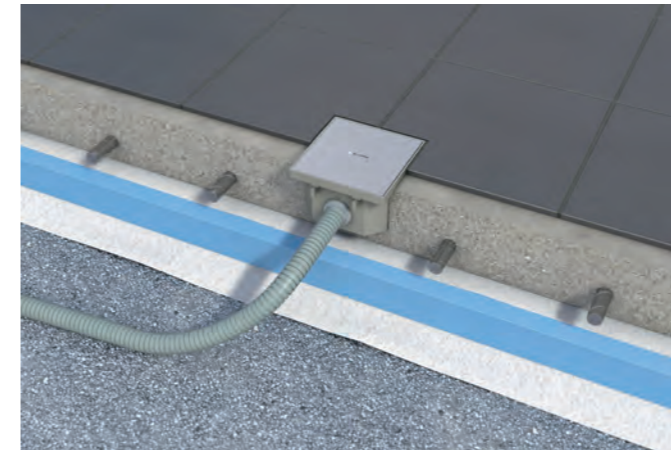

INSTALLATION ON JOISTS WITHOUT TERRACE KIT BUBOX CLASSIC BUBOX LINE



INSTALLATION ON HOLLOW FLOOR WITH TERRACE KIT (WOOD OR TILE ON SUPPORTS) BUBOX CLASSIC BUBOX LINE



INSTALLATION ON HOLLOW FLOOR WITHOUT TERRACE KIT (WOOD OR TILE ON SUPPORTS) BUBOX CLASSIC BUBOX LINE



For a flush floor installation without the terrace kit, use the leveling plate. (ref.: BFK119)



www.modelec.com

COMMERCIAL SERVICE

ZA Méré Gare
78490 Méré - FRANCE
+33 (0)1 34 86 86 65
contact@modul.com