



EL



S



D



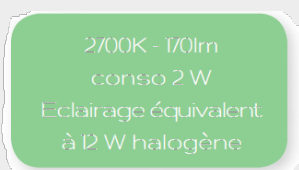
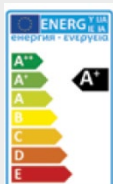

1 INFORMATIONS GÉNÉRALES

- **Matériau:** Laiton 5mm
- **Poids:** 390g **EL** / 420g **S** / 530g **D**
- **Entraxe vis:** S/D 60mm EL : 107mm
- **Fixation:** À vis uniquement
- **Montage:** 3 minutes vis
- **Boîtes d'encastrement compatibles:**
LEG 080031 **S**
LEG 080032 **D**
ARD 432002 **EL**
- **Longueur de flexible disponible :**
20 cm / 30 cm / 40 cm



2 FINITIONS

Embout	Blanc	Acier	Acier	Chrome	Chrome	Noir
						
Façade	Blanc Mat 413	Acier Brossé 412	Nickel Satiné 418	Chrome Miroir 415	Canon de Fusil 414	Noir Mat 408

Embout	Doré	Laiton	Laiton	Doré	Bronze	Laiton
						
Façade	Blanc Email 424	Laiton Brossé 410	Laiton Satiné 419	Or Miroir 421	Vieux Bronze 417	Cuivre Satiné 423

3 FORMATS

Dimensions en mm

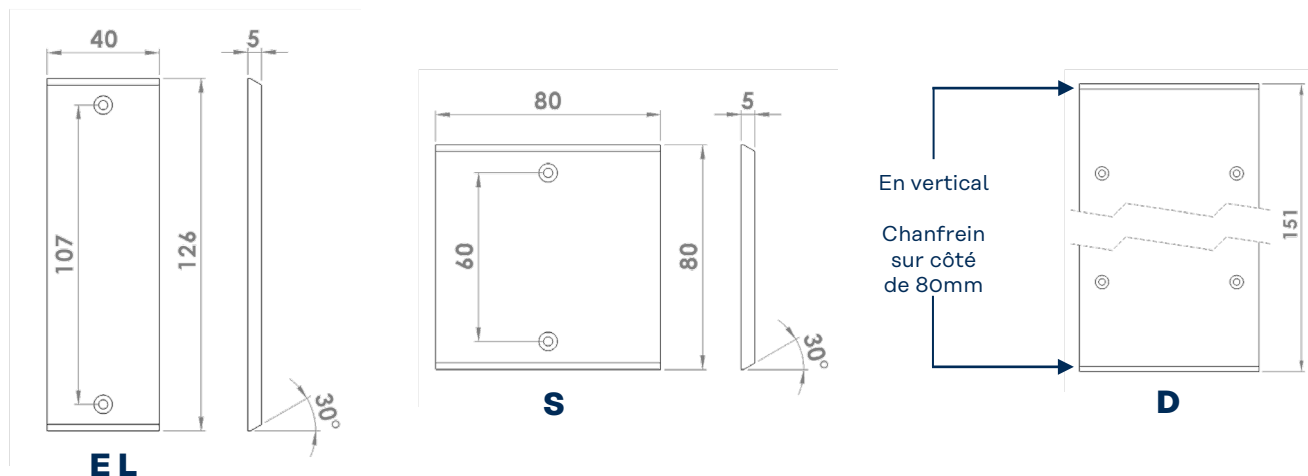

4 FONCTIONS DISPONIBLES

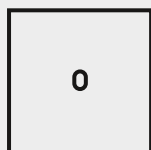

B1
1 Levier

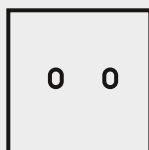

B2
2 Leviers

2 Design d'embout :



Cône



Tube

LEXIQUE

Levier : va-et-vient / poussoir / permutateur / volet roulant

Les gainages en cuir pour liseuse

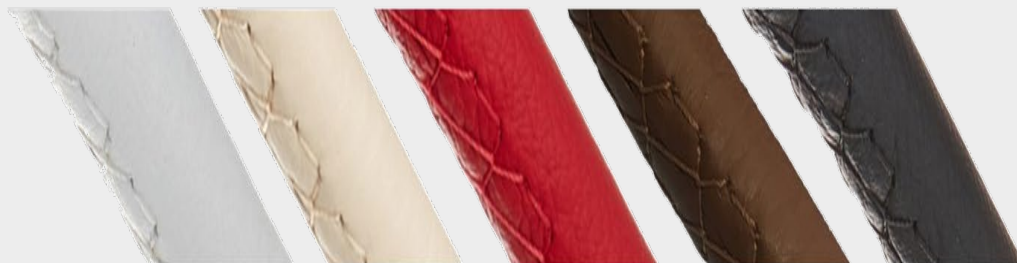

Cuir blanc
CUIR1

Cuir beige
CUIR2

Cuir rouge
CUIR3

Cuir marron
CUIR4

Cuir noir
CUIR5

5 CABLAGE

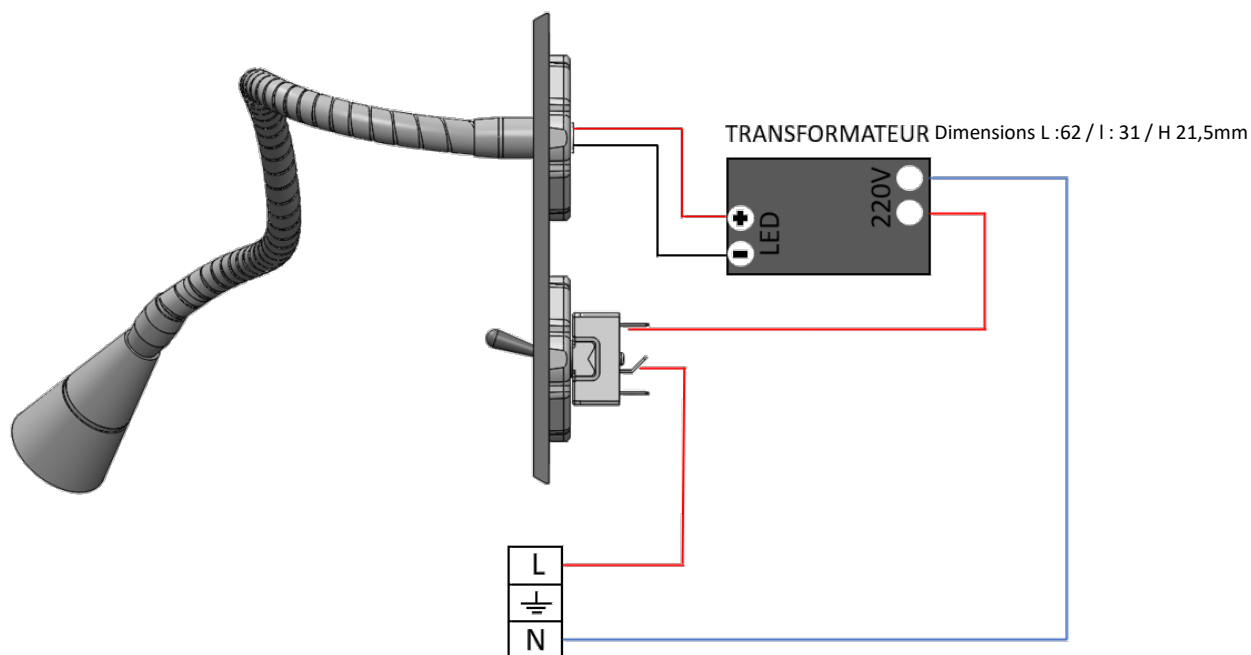

6 MONTAGE

1. Réaliser le câblage du mécanisme selon le schéma correspondant.
2. Enclencher simplement l'ensemble façade + mécanisme sur le boîtier d'encastrement standard puis visser (4 vis empreinte Torx fournies).
3. Veiller à un positionnement vertical correct.

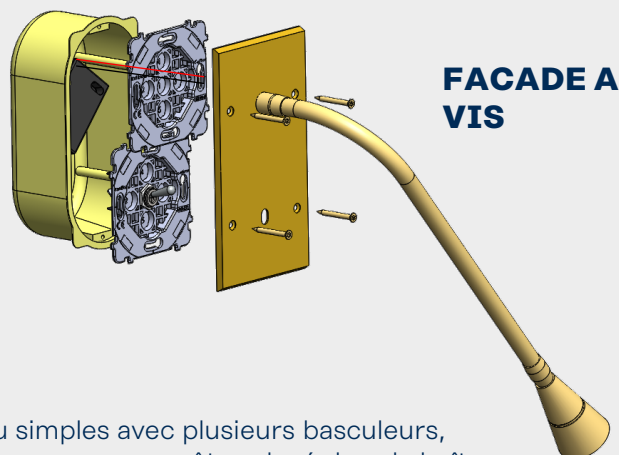

! Remarque : Pour les façades étroites longues ou simples avec plusieurs basculeurs, (exemple : catalogue 2064xx), le transformateur ne pourra pas être placé dans la boîte d'encastrement. Il devra être placé derrière la cloison et il faudra veiller à sa bonne isolation électrique.

