

# Satin Création Désir



# Satin Création Désir



## La Gamme



Gamme	Satin Désir- Simple				Satin Désir- Double				Satin Désir- Triple			
Référence	808	810	812	814	808	810	812	814	808	810	812	814
Finition	satin noir (Soft touch)	satin blanc (Soft touch)	satin alu	satin doré	satin noir (Soft touch)	satin blanc (Soft touch)	satin alu	satin doré	satin noir (Soft touch)	satin blanc (Soft touch)	satin alu	satin doré
Basculeur	Noir	Blanc	Acier	Doré	Noir	Blanc	Acier	Doré	Noir	Blanc	Acier	Doré
Dimensions façades simples	80 x 80 mm				152 x 80 mm				223 x 80 mm			
Préconisation de boîtes d'encastrement	Toutes boîtes standard Profondeur selon mécanisme				Toutes boîtes standard double-entraxe de 71 mm				Toutes boîtes standard triple-entraxe de 71 mm			

**LES FACADES**

**DIMENSION DES FACADES**

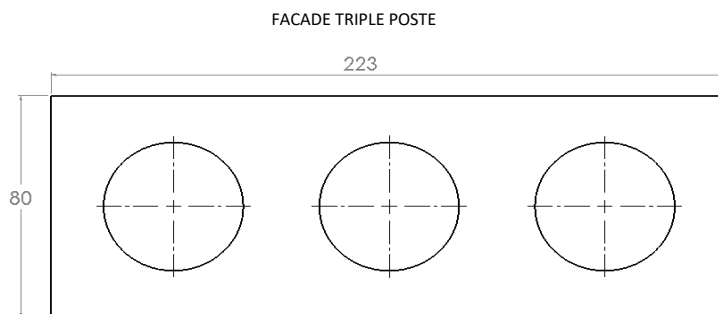
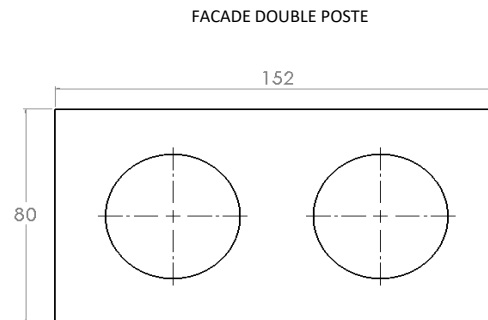
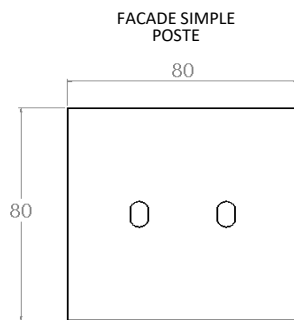

**FIXATION - MONTAGE**

**FIXATION SUR BOITIER STANDARD**

**RECOMMANDATIONS :**

1-IL FAUT IMPERATIVEMENT QUE LE BOITIER POSSEDE DES POINTS D'ANCRAGE AVEC ENTRAXE 60 mm



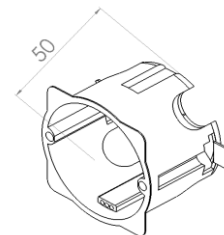
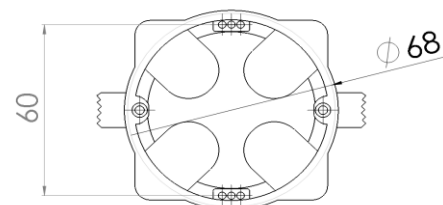



3-PROFONDEUR DE BOITIER : IL EST PREFERABLE D'UTILISER DES BOITIERS DE PROFONDEUR 50 mm





















**MECANISMES**

Ces mécanismes peuvent être utilisés sur les façades simple poste, double poste et triple poste

**Les Interrupteurs**

			LEVIER NOIR (086-XXXBNO)	LEVIER ACIER (086-XXXBAC)	LEVIER DORE (086-XXXBOR)	LEVIER BLANC (086-XXXBBL)
-030B		Mécanisme 1 Va-et-vient	086-030BNO	086-030BAC	086-030BOR	086-030BBL
-050B		Mécanisme 2 Va-et-vient	086-050BNO	086-050BAC	086-050BOR	086-050BBL
-210B		Mécanisme 1 Poussoir	086-210BNO	086-210BAC	086-210BOR	086-210BBL
-250B		Mécanisme 2 Poussoirs	086-250BNO	086-250BAC	086-250BOR	086-250BBL
-070B		Mécanisme 1 Va-et-vient + 1 Poussoir	086-070BNO	086-070BAC	086-070BOR	086-070BBL
-180B		Mécanisme Volet roulant	086-180BNO	086-180BAC	086-180BOR	086-180BBL











**Prises & Média**

-320B		Mécanisme Prise 2P+T	086-320B				
-360B		Mécanisme TV	086-360B				
-370B		Mécanisme TV-FM	086-370B				
-380B		Mécanisme TV-FM-SAT	086-380B				
-190B		Mécanisme Sortie de câble	086-190B				
-161B		Mécanisme nue	086-161B				
-510B		Mécanisme Chargeur USB	086-510B				
-390B		Mécanisme RJ45 Cat 6 (3M)				086-390B	
-400B		Mécanisme double RJ45 Cat 6 (3M)				086-400B	
-410B		Mécanisme RJ45 Cat 6 BLINDE (3M)				086-410B	
-420B		Mécanisme double RJ45 Cat 6 BLINDE (3M)				086-420B	
-430B		Mécanisme HDMI				086-430B	
-440B		Mécanisme double HDMI				086-440B	
-450B		Mécanisme USB Data				086-450B	
-460B		Mécanisme double USB Data				086-460B	
-470B		Mécanisme HP				086-470B	
-480B		Mécanisme double HP				086-480B	
-490B		Mécanisme RJ45 CAT 6 + HDMI				086-490B	
-500B		Mécanisme USB Data + HDMI				086-500B	



**FACADES SIMPLES**







Dimensions de la façade simple poste : 80x80x7 mm

			Noir Soft Touch	Biano Soft Touch	Silver	Doré
			808	810	812	814
Couleur de levier recommandé			NOIR	BLANC	ACIER	DORE
131-		Façade 1 trou oblong (B1)	131-808	131-810	131-812	131-814
132-		Façade 2 trous oblongs (B2)	132-808	132-810	132-812	132-814
190-		Façade Prise 2P+T (R1)	190-808	190-810	190-812	190-814
192-		Façade 1 trou média (M1)	192-808	192-810	192-812	192-814
193-		Façade 2 trous médias (M2)	193-808	193-810	193-812	193-814
194-		Façade 1 trou pour TV (C1)	194-808	194-810	194-812	194-814
195-		Façade 2 trous pour TV-FM (C2)	195-808	195-810	195-812	195-814
196-		Façade 3 trous pour TV/FM/SAT (C3)	196-808	196-810	196-812	196-814
197-		Façade Sortie de câble + Cache (SC)	197-808	197-810	197-812	197-814
198-		Façade obturateur (O1)	198-808	198-810	198-812	198-814

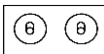
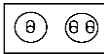

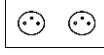
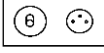
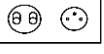
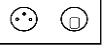
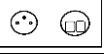
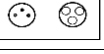
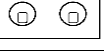
**FACADES DOUBLES HORIZONTALES**

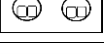
Dimensions de la façade double poste : 152x80x7 mm

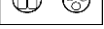
			Noir Soft Touch	Blanc Soft Touch	Silver	Doré
			808	810	812	814
		Couleur de levier recommandé	NOIR	BLANC	ACIER	DORE
172-		Façade 2 trous oblongs (B1 B1)	172-808	172-810	172-812	172-814
177-		Façade 3 trous oblongs (B1 B2)	177-808	177-810	177-812	177-814
174-		Façade 4 trous oblongs (B2 B2)	174-808	174-810	174-812	174-814
260-		Façade dbl Prise 2P+T (R1 R1)	260-808	260-810	260-812	260-814
261-		Façade 1 trou oblong + 1 prise 2P+T (B1 R1)	261-808	261-810	261-812	261-814
262-		Façade 2 trous oblongs + 1 prise 2P+T (B2 R1)	262-808	262-810	262-812	262-814
263-		Façade 1 prise 2P+T + 1 trou MEDIA (R1 M1)	263-808	263-810	263-812	263-814
264-		Façade 1 prise 2P+T + 2 trous MEDIA (R1 M2)	264-808	264-810	264-812	264-814
265-		Façade 1 prise 2P+T + 3 trous TV-FM-SAT (R1 C3)	265-808	265-810	265-812	265-814
266-		Façade 1 trou MEDIA + 1 trou MEDIA (M1 M1)	266-808	266-810	266-812	266-814
267-		Façade 1 trou MEDIA + 2 trous MEDIA (M1 M2)	267-808	267-810	267-812	267-814
268-		Façade 2 trous MEDIA + 2 trous MEDIA (M2 M2)	268-808	268-810	268-812	268-814
269-		Façade 1 trou MEDIA + 3 trous TV-FM-SAT (M1 C3)	269-808	269-810	269-812	269-814
270-		Façade 2 trous MEDIA + 3 trous TV-FM-SAT (M2 C3)	270-808	270-810	270-812	270-814

**FACADES DOUBLES VERTICALES**

Dimensions de la façade double poste : 80x152x7 mm

			<b>Noir Soft Touch</b>	<b>Blanc Soft Touch</b>	<b>Silver</b>	<b>Doré</b>
			<b>808</b>	<b>810</b>	<b>812</b>	<b>814</b>
		<b>Couleur de levier recommandé</b>	<b>NOIR</b>	<b>BLANC</b>	<b>ACIER</b>	<b>DORE</b>
152-		Façade 2 trous oblongs (B1 B1)	152-808	152-810	152-812	152-814
155-		Façade 3 trous oblongs (B1 B2)	155-808	155-810	155-812	155-814
154-		Façade 4 trous oblongs (B2 B2)	154-808	154-810	154-812	154-814
280-		Façade dbl Prise 2P+T (R1 R1)	280-808	280-810	280-812	280-814
281-		Façade 1 trou oblong + 1 prise 2P+T (B1 R1)	281-808	281-810	281-812	281-814
282-		Façade 2 trous oblongs + 1 prise 2P+T (B2 R1)	282-808	282-810	282-812	282-814
283-		Façade 1 prise 2P+T + 1 trou MEDIA (R1 M1)	283-808	283-810	283-812	283-814
284-		Façade 1 prise 2P+T + 2 trous MEDIA (R1 M2)	284-808	284-810	284-812	284-814
285-		Façade 1 prise 2P+T + 3 trous TV-FM-SAT (R1 C3)	285-808	285-810	285-812	285-814
286-		Façade 1 trou MEDIA + 1 trou MEDIA (M1 M1)	286-808	286-810	286-812	286-814
287-		Façade 1 trou MEDIA + 2 trous MEDIA (M1 M2)	287-808	287-810	287-812	287-814
288-		Façade 2 trous MEDIA + 2 trous MEDIA (M2 M2)	288-808	288-810	288-812	288-814
289-		Façade 1 trou MEDIA + 3 trous TV-FM-SAT (M1 C3)	289-808	289-810	289-812	289-814
290-		Façade 2 trous MEDIA + 3 trous TV-FM-SAT (M2 C3)	290-808	290-810	290-812	290-814



**FACADES TRIPLES HORIZONTALES**













Dimensions de la façade triple poste : 223x80x7 mm

		Noir Soft Touch	Blanc Soft Touch	Silver	Doré	
		808	810	812	814	
Couleur de levier recommandé		NOIR	BLANC	ACIER	DORE	
303-		Façade 3 trous oblongs	303-808	303-810	303-812	303-814
304-		Façade 1 trou oblong + 1 trou oblong + 2 trous oblongs	304-808	304-810	304-812	304-814
305-		Façade 1 trou oblong + 2 trous oblongs + 2 trous oblongs	305-808	305-810	305-812	305-814
306-		Façade 2 trous oblongs + 2 trous oblong + 2 trous oblongs	306-808	306-810	306-812	306-814
310-		Façade 3 prises 2P+T	310-808	310-810	310-812	310-814
311-		Façade 1 trou oblong + 2 prises 2P+T	311-808	311-810	311-812	311-814
312-		Façade 2 trous oblongs + 2 prises 2P+T	312-808	312-810	312-812	312-814
313-		Façade 2 prises 2P+T + 1 trou MEDIA	313-808	313-810	313-812	313-814
314-		Façade 2 prises 2P+T + 2 trous MEDIA	314-808	314-810	314-812	314-814
315-		Façade 2 prises 2P+T + 3 trous TV-FM-SAT	315-808	315-810	315-812	315-814
316-		Façade 1 prise 2P+T + 1 trou MEDIA + 1 trou MEDIA	316-808	316-810	316-812	316-814
317-		Façade 1 prise 2P+T + 2 trous MEDIA + 2 trous MEDIA	317-808	317-810	317-812	317-814
318-		Façade 1 prise 2P+T + 1 trou MEDIA + 2 trous MEDIA	318-808	318-810	318-812	318-814
320-		Façade 1 trou MEDIA + 1 trou MEDIA + 1 trou MEDIA	320-808	320-810	320-812	320-814
323-		Façade 2 trous MEDIA + 2 trous MEDIA + 2 trous MEDIA	323-808	323-810	323-812	323-814
324-		Façade 1 prise 2P+T + 1 trou MEDIA + 3 trous TV-FM-SAT	324-808	324-810	324-812	324-814
325-		Façade 1 prise 2P+T + 2 trous MEDIA + 3 trous TV-FM-SAT	325-808	325-810	325-812	325-814



FAÇADES TRIPLES HORIZONTALES

Dimensions de la façade triple poste : 223x80x7 mm

		Noir Soft Touch	Biano Soft Touch	Silver	Doré	
		808	810	812	814	
Couleur de levier recommandé		NOIR	BLANC	ACIER	DORE	
353-		Façade 3 trous oblongs	353-808	353-810	353-812	353-814
354-		Façade 1 trou oblong + 1 trou oblong + 2 trous oblongs	354-808	354-810	354-812	354-814
355-		Façade 1 trou oblong + 2 trous oblongs + 2 trous oblongs	355-808	355-810	355-812	355-814
356-		Façade 2 trous oblongs + 2 trous oblong + 2 trous oblongs	356-808	356-810	356-812	356-814
360-		Façade 3 prises 2P+T	360-808	360-810	360-812	360-814
361-		Façade 1 trou oblong + 2 prises 2P+T	361-808	361-810	361-812	361-814
362-		Façade 2 trous oblongs + 2 prises 2P+T	362-808	362-810	362-812	362-814
363-		Façade 2 prises 2P+T + 1 trou MEDIA	363-808	363-810	363-812	363-814
364-		Façade 2 prises 2P+T + 2 trous MEDIA	364-808	364-810	364-812	364-814
365-		Façade 2 prises 2P+T + 3 trous TV-FM-SAT	365-808	365-810	365-812	365-814
366-		Façade 1 prise 2P+T + 1 trou MEDIA + 1 trou MEDIA	366-808	366-810	366-812	366-814
367-		Façade 1 prise 2P+T + 2 trous MEDIA + 2 trous MEDIA	367-808	367-810	367-812	367-814
368-		Façade 1 prise 2P+T + 1 trou MEDIA + 2 trous MEDIA	368-808	368-810	368-812	368-814
370-		Façade 1 trou MEDIA + 1 trou MEDIA + 1 trou MEDIA	370-808	370-810	370-812	370-814
373-		Façade 2 trous MEDIA + 2 trous MEDIA + 2 trous MEDIA	373-808	373-810	373-812	373-814
374-		Façade 1 prise 2P+T + 1 trou MEDIA + 3 trous TV-FM-SAT	374-808	374-810	374-812	374-814
375-		Façade 1 prise 2P+T + 2 trous MEDIA + 3 trous TV-FM-SAT	375-808	375-810	375-812	375-814