

Bois Création Désir

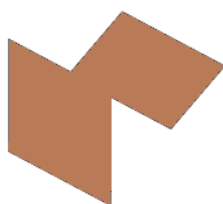

Bois Création Désir



La Gamme



Gamme	Création Désir				
Basculeur	leviers droit acier				
Référence	712	714	716	718	720
Finition bois	Hêtre naturel à teinter	Chêne finition Wengé	Chêne Verni	Palissandre Verni	Noyer Verni
Dimensions façades simples	90 x 85 mm, épaisseur 7,2 mm				
Dimensions façades doubles	165 x 85 mm, épaisseur 7,2 mm Entraxe de 71mm Horizontale ou Verticale (selon fonctions)				
Dimensions façades triples	236 x 85 mm, épaisseur 7,2 mm Entraxe de 71mm Horizontale ou Verticale (selon fonctions)				
Préconisation de boîtes d'encastrement	Toutes boîtes standard Profondeur selon mécanisme				

LES FACADES

DIMENSION DES FACADES

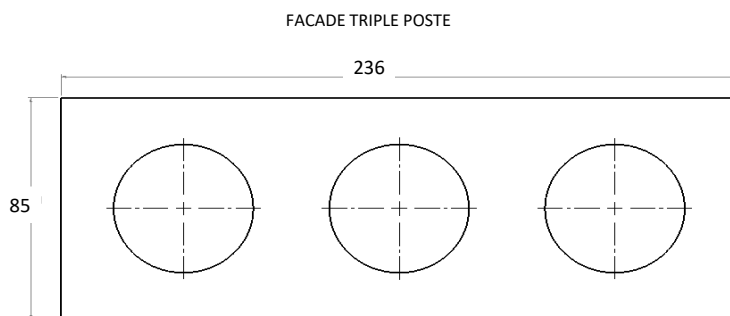
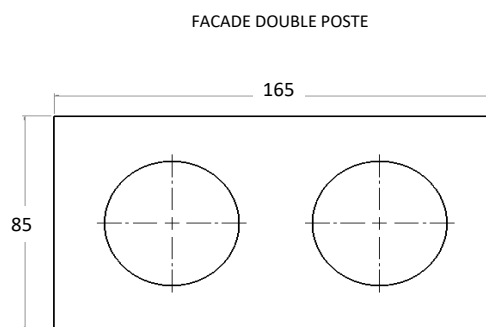
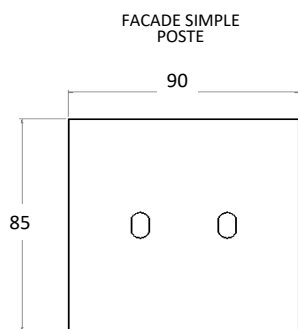

FIXATION - MONTAGE

FIXATION SUR BOITIER STANDARD

RECOMMANDATIONS :

1-IL FAUT IMPERATIVEMENT QUE LE BOITIER POSSEDE
DES POINTS D'ANCRAGE AVEC ENTRAXE 60 mm



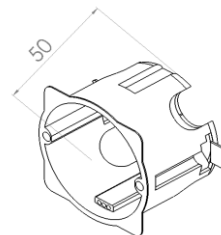
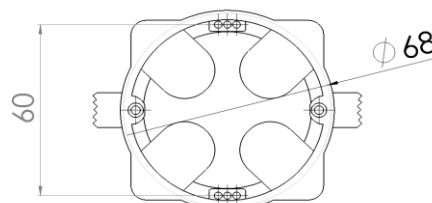



3-PROFONDEUR DE BOITIER :
IL EST PREFERABLE D'UTILISER DES BOITIERS DE PROFONDEUR
50 mm









MECANISMES













Ces mécanismes peuvent être utilisés sur les façades simple poste, double poste et triple poste

Les Interrupteurs

			LEVIER ACIER (086-XXXBAC)
-030B		Mécanisme 1 Va-et-vient	086-030BAC
-050B		Mécanisme 2 Va-et-vient	086-050BAC
-210B		Mécanisme 1 Pousoir	086-210BAC
-250B		Mécanisme 2 Pousoirs	086-250BAC
-070B		Mécanisme 1 Va-et-vient + 1 Pousoir	086-070BAC
-180B		Mécanisme Volet roulant	086-180BAC

Prises & Média











-320B		Mécanisme Prise 2P+T	086-320B
-360B		Mécanisme TV	086-360B
-370B		Mécanisme TV-FM	086-370B
-380B		Mécanisme TV-FM-SAT	086-380B
-190B		Mécanisme Sortie de câble	086-190B
-161B		Mécanisme nue	086-161B
-510B		Mécanisme Chargeur USB	086-510B

-390B		Mécanisme RJ45 Cat 6 (3M)	086-390B
-400B		Mécanisme double RJ45 Cat 6 (3M)	086-400B
-410B		Mécanisme RJ45 Cat 6 BLINDE (3M)	086-410B
-420B		Mécanisme double RJ45 Cat 6 BLINDE (3M)	086-420B
-430B		Mécanisme HDMI	086-430B
-440B		Mécanisme double HDMI	086-440B
-450B		Mécanisme USB Data	086-450B
-460B		Mécanisme double USB Data	086-460B
-470B		Mécanisme HP	086-470B
-480B		Mécanisme double HP	086-480B
-490B		Mécanisme RJ45 CAT 6 + HDMI	086-490B
-500B		Mécanisme USB Data + HDMI	086-500B



FACADES SIMPLES







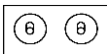
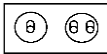

Dimensions de la façade simple poste : 90x85X7 mm

			Hêtre Naturel	Chêne Wongé	Chêne Verni	Palissandre	Noyer verni
			712	714	716	718	720
Couleur de levier recommandé			ACIER	ACIER	ACIER	ACIER	ACIER
131-		Façade 1 trou oblong (B1)	131-712	131-714	131-716	131-718	131-720
132-		Façade 2 trous oblongs (B2)	132-712	132-714	132-716	132-718	132-720
190-		Façade Prise 2P+T (R1)	190-712	190-714	190-716	190-718	190-720
192-		Façade 1 trou média (M1)	192-712	192-714	192-716	192-718	192-720
193-		Façade 2 trous médias (M2)	193-712	193-714	193-716	193-718	193-720
194-		Façade 1 trou pour TV (C1)	194-712	194-714	194-716	194-718	194-720
195-		Façade 2 trous pour TV-FM (C2)	195-712	195-714	195-716	195-718	195-720
196-		Façade 3 trous pour TV/FM/SAT (C3)	196-712	196-714	196-716	196-718	196-720
197-		Façade Sortie de câble + Cache (SC)	197-712	197-714	197-716	197-718	197-720
198-		Façade obturateur (O1)	198-712	198-714	198-716	198-718	198-720

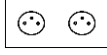
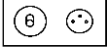
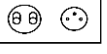
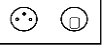
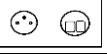

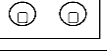
FAÇADES DOUBLES HORIZONTALES

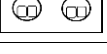
Dimensions de la façade double poste : 165x85x7 mm

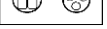
		Hêtre Naturel	Chêne Wongé	Chêne Verni	Palissandre	Noyer verni	
		712	714	716	718	720	
Couleur de levier recommandé		ACIER	ACIER	ACIER	ACIER	ACIER	
172-		Façade 2 trous oblongs (B1 B1)	172-712	172-714	172-716	172-718	172-720
177-		Façade 3 trous oblongs (B1 B2)	177-712	177-714	177-716	177-718	177-720
174-		Façade 4 trous oblongs (B2 B2)	174-712	174-714	174-716	174-718	174-720
260-		Façade dbl Prise 2P+T (R1 R1)	260-712	260-714	260-716	260-718	260-720
261-		Façade 1 trou oblong + 1 prise 2P+T (B1 R1)	261-712	261-714	261-716	261-718	261-720
262-		Façade 2 trous oblongs + 1 prise 2P+T (B2 R1)	262-712	262-714	262-716	262-718	262-720
263-		Façade 1 prise 2P+T + 1 trou MEDIA (R1 M1)	263-712	263-714	263-716	263-718	263-720
264-		Façade 1 prise 2P+T + 2 trous MEDIA (R1 M2)	264-712	264-714	264-716	264-718	264-720
265-		Façade 1 prise 2P+T + 3 trous TV-FM-SAT (R1 C3)	265-712	265-714	265-716	265-718	265-720
266-		Façade 1 trou MEDIA + 1 trou MEDIA (M1 M1)	266-712	266-714	266-716	266-718	266-720
267-		Façade 1 trou MEDIA + 2 trous MEDIA (M1 M2)	267-712	267-714	267-716	267-718	267-720
268-		Façade 2 trous MEDIA + 2 trous MEDIA (M2 M2)	268-712	268-714	268-716	268-718	268-720
269-		Façade 1 trou MEDIA + 3 trous TV-FM-SAT (M1 C3)	269-712	269-714	269-716	269-718	269-720
270-		Façade 2 trous MEDIA + 3 trous TV-FM-SAT (M2 C3)	270-712	270-714	270-716	270-718	270-720

FACADES DOUBLES VERTICALES









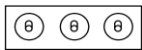
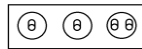

Dimensions de la façade double poste : 85x165x7 mm

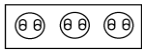
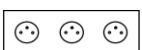
		Hêtre Naturel	Chêne Wengé	Chêne Verni	Palisandre	Noyer verni	
		712	714	716	718	720	
Couleur de levier recommandé		ACIER	ACIER	ACIER	ACIER	ACIER	
152-		Façade 2 trous oblongs (B1 B1)	152-712	152-714	152-716	152-718	152-720
155-		Façade 3 trous oblongs (B1 B2)	155-712	155-714	155-716	155-718	155-720
154-		Façade 4 trous oblongs (B2 B2)	154-712	154-714	154-716	154-718	154-720
280-		Façade dbl Prise 2P+T (R1 R1)	280-712	280-714	280-716	280-718	280-720
281-		Façade 1 trou oblong + 1 prise 2P+T (B1 R1)	281-712	281-714	281-716	281-718	281-720
282-		Façade 2 trous oblongs + 1 prise 2P+T (B2 R1)	282-712	282-714	282-716	282-718	282-720
283-		Façade 1 prise 2P+T + 1 trou MEDIA (R1 M1)	283-712	283-714	283-716	283-718	283-720
284-		Façade 1 prise 2P+T + 2 trous MEDIA (R1 M2)	284-712	284-714	284-716	284-718	284-720
285-		Façade 1 prise 2P+T + 3 trous TV-FM-SAT (R1 C3)	285-712	285-714	285-716	285-718	285-720
286-		Façade 1 trou MEDIA + 1 trou MEDIA (M1 M1)	286-712	286-714	286-716	286-718	286-720
287-		Façade 1 trou MEDIA + 2 trous MEDIA (M1 M2)	287-712	287-714	287-716	287-718	287-720
288-		Façade 2 trous MEDIA + 2 trous MEDIA (M2 M2)	288-712	288-714	288-716	288-718	288-720
289-		Façade 1 trou MEDIA + 3 trous TV-FM-SAT (M1 C3)	289-712	289-714	289-716	289-718	289-720
290-		Façade 2 trous MEDIA + 3 trous TV-FM-SAT (M2 C3)	290-712	290-714	290-716	290-718	290-720

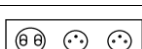
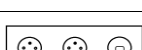
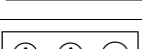
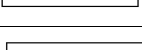
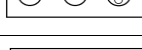
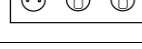

FACADES TRIPLES HORIZONTALES

Dimensions de la façade triple poste : 236x85x7 mm

		Hêtre Naturel	Chêne Wongé	Chêne Verni	Palissandre	Noyer verni	
		712	714	716	718	720	
Couleur de levier recommandé		ACIER	ACIER	ACIER	ACIER	ACIER	
303-		Façade 3 trous oblongs	303-712	303-714	303-716	303-718	303-720
304-		Façade 1 trou oblong + 1 trou oblong + 2 trous oblongs	304-712	304-714	304-716	304-718	304-720
305-		Façade 1 trou oblong + 2 trous oblongs + 2 trous oblongs	305-712	305-714	305-716	305-718	305-720
306-		Façade 2 trous oblongs + 2 trous oblong + 2 trous oblongs	306-712	306-714	306-716	306-718	306-720
310-		Façade 3 prises 2P+T	310-712	310-714	310-716	310-718	310-720
311-		Façade 1 trou oblong + 2 prises 2P+T	311-712	311-714	311-716	311-718	311-720
312-		Façade 2 trous oblongs + 2 prises 2P+T	312-712	312-714	312-716	312-718	312-720
313-		Façade 2 prises 2P+T + 1 trou MEDIA	313-712	313-714	313-716	313-718	313-720
314-		Façade 2 prises 2P+T + 2 trous MEDIA	314-712	314-714	314-716	314-718	314-720
315-		Façade 2 prises 2P+T + 3 trous TV-FM-SAT	315-712	315-714	315-716	315-718	315-720
316-		Façade 1 prise 2P+T + 1 trou MEDIA + 1 trou MEDIA	316-712	316-714	316-716	316-718	316-720
317-		Façade 1 prise 2P+T + 2 trous MEDIA + 2 trous MEDIA	317-712	317-714	317-716	317-718	317-720
318-		Façade 1 prise 2P+T + 1 trou MEDIA + 2 trous MEDIA	318-712	318-714	318-716	318-718	318-720
320-		Façade 1 trou MEDIA + 1 trou MEDIA + 1 trou MEDIA	320-712	320-714	320-716	320-718	320-720
323-		Façade 2 trous MEDIA + 2 trous MEDIA + 2 trous MEDIA	323-712	323-714	323-716	323-718	323-720
324-		Façade 1 prise 2P+T + 1 trou MEDIA + 3 trous TV-FM-SAT	324-712	324-714	324-716	324-718	324-720
325-		Façade 1 prise 2P+T + 2 trous MEDIA + 3 trous TV-FM-SAT	325-712	325-714	325-716	325-718	325-720

FACADES TRIPLES HORIZONTALES

Dimensions de la façade triple poste : 85x236x7 mm

		Hêtre Natural	Chêne Wengé	Chêne Verni	Palissandre	Noyer verni	
		712	714	716	718	720	
Couleur de levier recommandé		ACIER	ACIER	ACIER	ACIER	ACIER	
353-		Façade 3 trous oblongs	353-712	353-714	353-716	353-718	353-720
354-		Façade 1 trou oblong + 1 trou oblong + 2 trous oblongs	354-712	354-714	354-716	354-718	354-720
355-		Façade 1 trou oblong + 2 trous oblongs + 2 trous oblongs	355-712	355-714	355-716	355-718	355-720
356-		Façade 2 trous oblongs + 2 trous oblong + 2 trous oblongs	356-712	356-714	356-716	356-718	356-720
360-		Façade 3 prises 2P+T	360-712	360-714	360-716	360-718	360-720
361-		Façade 1 trou oblong + 2 prises 2P+T	361-712	361-714	361-716	361-718	361-720
362-		Façade 2 trous oblongs + 2 prises 2P+T	362-712	362-714	362-716	362-718	362-720
363-		Façade 2 prises 2P+T + 1 trou MEDIA	363-712	363-714	363-716	363-718	363-720
364-		Façade 2 prises 2P+T + 2 trous MEDIA	364-712	364-714	364-716	364-718	364-720
365-		Façade 2 prises 2P+T + 3 trous TV-FM-SAT	365-712	365-714	365-716	365-718	365-720
366-		Façade 1 prise 2P+T + 1 trou MEDIA + 1 trou MEDIA	366-712	366-714	366-716	366-718	366-720
367-		Façade 1 prise 2P+T + 2 trous MEDIA + 2 trous MEDIA	367-712	367-714	367-716	367-718	367-720
368-		Façade 1 prise 2P+T + 1 trou MEDIA + 2 trous MEDIA	368-712	368-714	368-716	368-718	368-720
370-		Façade 1 trou MEDIA + 1 trou MEDIA + 1 trou MEDIA	370-712	370-714	370-716	370-718	370-720
373-		Façade 2 trous MEDIA + 2 trous MEDIA + 2 trous MEDIA	373-712	373-714	373-716	373-718	373-720
374-		Façade 1 prise 2P+T + 1 trou MEDIA + 3 trous TV-FM-SAT	374-712	374-714	374-716	374-718	374-720
375-		Façade 1 prise 2P+T + 2 trous MEDIA + 3 trous TV-FM-SAT	375-712	375-714	375-716	375-718	375-720